

Stainless steel

TECHNICAL DATA BALL VALVE

Design:	3-way ball valve, full bore
Construction:	4-part design sealing on all sides Centre section radially removable.
Connection end:	Flange according to DIN 2501/1-EN 1092-1
Flange PN40	DN15-DN50
Flange PN16	DN65-DN100
Actuator connection:	According to DIN EN ISO 5211 [direct assembly]
Medium temperature:	-25°C to +180°C pressure-dependent
Medium pressure:	Max. 40 bar DN and temperature-dependent
Housing:	Stainless steel 1.4408
Screw-on parts:	Stainless steel 1.4408
Ball:	Stainless steel 1.4401
Ball seal:	R-PTFE (15%)
Spindle:	Stainless steel 1.4401 blow-out proof, antistatic
Spindle seal:	PTFE FKM O-ring

Item 9342 : T-PORT

Item 9343 : L-PORT

TECHNICAL DATA ACTUATOR

Design Feature:	Rack and pinion principle
Piston guide:	Self centering in housing
Housing:	Aluminum alloy anodized
Cover end caps:	Aluminum alloy, RAL 5002 blue painted
Seals:	NBR
Pinion:	Steel chemically hard nickel plated
Piston Rack:	Aluminum alloy
Pivot angle:	90° adjustable from +5° to -5
Operating temperature:	-15°C to +80°C
Torque max:	Torque table Pilot pressure table
Control medium:	Filtered & lubricated air according to Pneurop/ISO Kl. 5
Control pressure:	Rated to 6 bar
Actuator Valve:	according to DIN ISO 5211
Actuator Control valve:	according to Namur resp. VDI/VDE 3845
Actuator Signal devices:	according to Namur resp. VDI/VDE 3845
Position indicator :	optical, mounted in scope of delivery
Approval :	ATEX 2014/34/EU

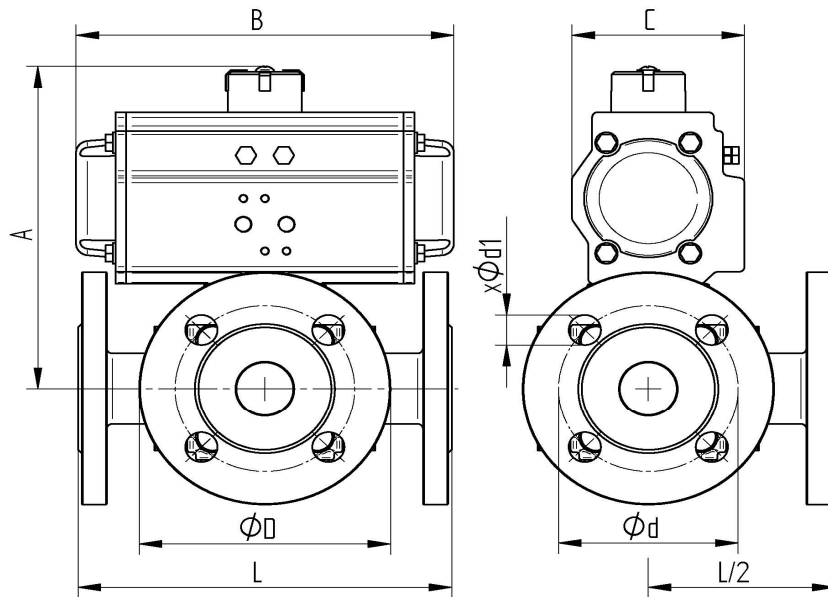

Art. No.	DN	L mm	øD mm	ød mm	xød1 mm	A mm	B mm	C mm
PE01 9342_9343-04	15	152	95	65	4xø14	138	154	71
PE02 9342_9343-05	20	167	105	75	4xø14	162	189	90
PE03 9342_9343-06	25	180	115	85	4xø14	179	210	103
PE04 9342_9343-07	32	190	140	100	4xø18	204	229	113
PE05 9342_9343-08	40	212	150	110	4xø18	221	264	126
PE06 9342_9343-09	50	230	165	125	4xø18	241	266	139
PE07 9342_9343-10	65	290	185	145	4xø18	301	337	157
PE07 9342_9343-11	80	310	200	160	8xø18	314	337	157
PE08 9342_9343-12	100	350	220	180	8xø18	354	377	178