

### Stainless steel

#### TECHNICAL DATA BALL VALVE:

Body material:	Stainless steel 1.4408
Flange material:	Stainless steel 1.4408
Ball material:	Stainless steel 1.4401
Ball seat:	R-PTFE (15%)
Stem material:	Stainless steel 1.4401
Stem packing:	PTFE   FKM O-Ring
Body wall thickness:	Acc.to EN 12516-1
Flange connection:	Acc.to DIN 2501/1 - EN 1092-1
Face to face dimension:	Acc.to EN558-1 Row 27
ISO Flange:	Acc.to DIN EN ISO 5211
Safety:	Blow-out proofed, antistatic
Medium temperature:	-25°C up to max. +180°C, pressure dependent
Pressure rating:	Max. PN 40 bar, temperature dependent
Approval:	ATEX II 2G Ex h IIB T2 Gb ATEX II 2D Ex h IIIIB T280° Db Firesafe acc.to DIN EN ISO 10497

#### TECHNICAL DATA ACTUATOR

Functionality :	*OPEN* * CLOSE
Control voltage :	230V AC 50/60 Hz.   24V DC
Operating temperature :	- 25°C up to max. + 55°C
Angle of rotation :	set 90 ° for ball valves max. 360 °
Protection class :	IP 67
Electrical connection :	1 M20 Screw: Voltage supply 1 M20 Screw: Position feedback signal
Limit switch :	2 pieces for 90° rotation 2 pieces for feedback *Open* *Close*
Position indicator:	optical
Actuator connection:	Acc.to DIN EN ISO 5211 [direct assembly]
Housing cover:	Aluminium alloy coated
Manual override:	Allen key

### Flange connections

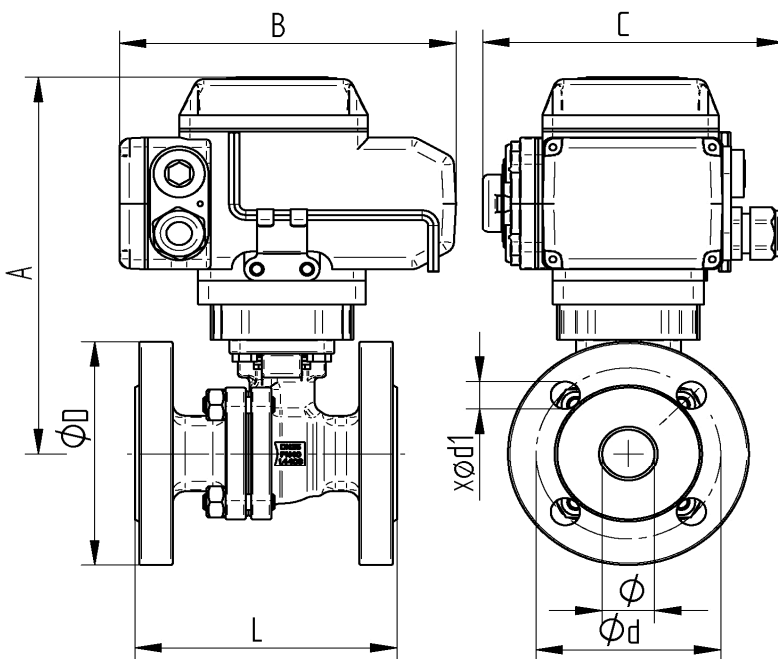

Item No. 230V 50 Hz.	Item No. 24V DC	DN	ø mm	A mm	B mm	C mm	L mm	øD mm	ød mm	xød1mm	Sek.	Nm
AE06 0920-07	AE07 0920-07	32	32	205	162	138	130	140	100	4xø18	25	50
AE06 0920-08	AE07 0920-08	40	38	211	162	138	140	150	110	4xø18	25	50
AE06 0920-09	AE07 0920-09	50	50	219	162	138	150	165	125	4xø18	25	50
AE09 0920-10	AE10 0920-10	65	65	268	196	145	170	185	145	4xø18	30	100
AE09 0920-11	AE10 0920-11	80	76	281	196	145	180	200	160	8xø18	30	100
AE11 0920-12	AE12 0920-12	100	94	342	255	182	190	220	180	8xø18	30	200
AE13 0920-13	AE14 0920-13	125	125	381	255	182	325	250	210	8xø18	30	400
AE13 0920-14	AE14 0920-14	150	150	399	255	182	350	285	240	8xø22	30	400