

Stainless steel

TECHNICAL DATA BALL VALVE:

Design:	3-piece model with full port
Connection:	Butt welded
Body material:	Stainless steel 1.4408
Body cap material:	Stainless steel 1.4408
Ball material:	Stainless steel 1.4401
Ball seat:	R-PTFE (15%)
Stem material:	Stainless steel 1.4401
Stem packing:	PTFE FKM O-Ring
ISO Flange:	Acc.to DIN EN ISO 5211
Safety:	Blow-out proof design, antistatic
Medium temperature:	-25°C up to max. +180°C, pressure dependent
Pressure rating:	Max. PN 63bar, temperature dependent
Approval:	ATEX II 2G Ex h IIB T2 Gb ATEX II 2D Ex h IIIB T280° Db

TECHNICAL DATA ACTUATOR

Functionality :	*OPEN* * CLOSE
Control voltage :	230V AC 50/60 Hz. 24V DC
Operating temperature :	- 25°C up to max. + 55°C
Angle of rotation :	set 90 ° for ball valves max. 360 °
Protection class :	IP 67
Electrical connection :	1 M20 Screw: Voltage supply 1 M20 Screw: Position feedback signal
Limit switch :	2 pieces for 90° rotation 2 pieces for feedback *Open* *Close*
Position indicator:	optical
Actuator connection:	Acc.to DIN EN ISO 5211 [direct assembly]
Housing cover:	Aluminium alloy coated
Manual override:	Allen key

Butt welded ends

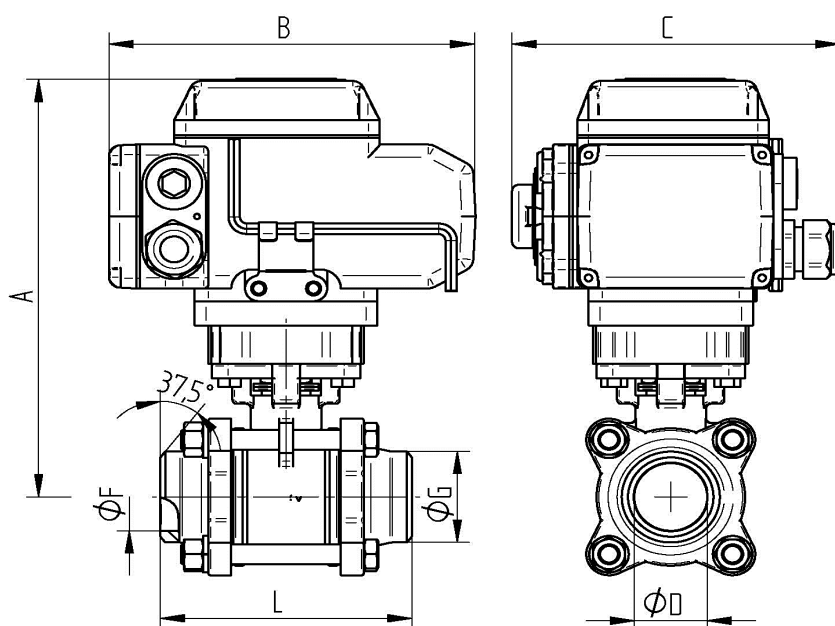

Art. Nr. 230V 50 Hz.	Art. Nr. 24V DC	DN	øD mm	L mm	øF mm	øG mm	A mm	B mm	C mm	Sek.	Nm
AE04 9337-07	AE05 9337-07	32	32	110	32	42,7	198	162	138	12	30
AE04 9337-08	AE05 9337-08	40	40	125	40	57,6	204	162	138	12	30
AE06 9337-09	AE07 9337-09	50	50	150	50	60,5	212	162	138	25	50
AE09 9337-10	AE10 9337-10	65	65	190	65	76	258	196	145	30	100
AE09 9337-11	AE10 9337-11	80	80	220	80	93	271	196	145	30	100
AE11 9337-12	AE12 9337-12	100	100	270	100	116	322	255	182	30	200