

Brass

TECHNICAL DATA

Version:	Universal non-return valve
Mounting position :	Horizontal vertical
Connection end :	Female thread according to DIN EN ISO 228-1
Housing material :	Brass CW617N
Valve disc :	Brass CW617N
Pin :	Brass CW617N
Spring :	Stainless steel 1.4301
Seal :	NBR
Operating temperature :	-20°C up to max. +150°C pressure-dependent
Operating pressure :	Max. PN25 bar temperature-dependent
Opening pressure	0.03-0.05 bar



Connecting thread female/female

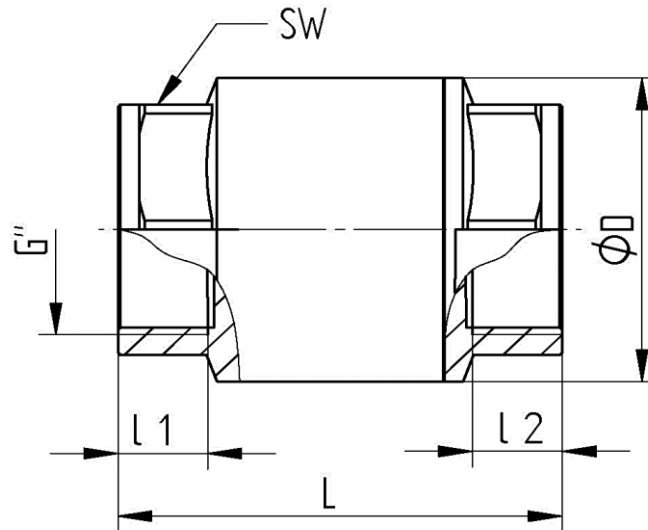

Art. Nr.	G"	øDN	L mm	l 1 mm	l 2 mm	øD mm	SW mm	PN(bar)	Weight (g)
1422-03NBR	3/8"	15	54	12	16	34,5	21	25	170
1422-04NBR	1/2"	16.4	57	13	14	34,5	25	25	180
1422-05NBR	3/4"	22	60	14,5	14,5	42	31	25	260
1422-06NBR	1"	25	73	17,5	17,5	48	40	25	425
1422-07NBR	1 1/4"	32	83	17	18,5	60,5	50	16	650
1422-08NBR	1 1/2"	39.5	93	19	19	70,8	55	16	875
1422-09NBR	2"	50	100	21	21	87	67	16	1320